

DEX™

A WIRELESS WORLD

USER INSTRUCTIONS

TV-DEX

WIDEX®
HIGH DEFINITION HEARING



CONTENTS

PACKAGE CONTENTS	5
DESCRIPTION OF DEVICE	7
TV-CONTROLLER II	9
TV-BASE	10
LIGHT-EMITTING DIODES	12
GETTING STARTED	13
Connecting the units:	13
When using more than one tv-base	20
USAGE	21
Instructions for lanyard usage	22
Transmission	24
Adjusting the volume	27
Mute	27
Room off	28
Recharging the battery	29
CARING FOR YOUR TV-DEX	31
WARNINGS	34
SAFETY WARNING	37

TROUBLESHOOTING	38
REGULATORY INFORMATION	41
SYMBOLS.....	47

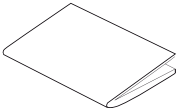
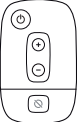
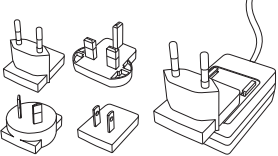
PACKAGE CONTENTS

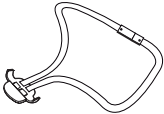
User manual	 A simple line drawing of a folded sheet of paper, representing the user manual.
TV-Controller II	 A line drawing of a handheld TV remote control. It features a power button at the top, followed by plus and minus buttons, and a square button at the bottom.
Box 1: Mini USB power supply	 A collection of components for a Mini USB power supply. It includes a Mini USB cable, a power adapter with two pins, a small PCB with a USB port, and a larger PCB with a Mini USB port and a power input. A power cord is also shown connected to the larger PCB.

<p>Box 2: Lanyard</p>	
<p>Box 3: a. 3.5 mm jack to 3.5 mm jack cable b. 3.5 mm jack to phono cable</p>	 <p>a. b.</p>
<p>Box 4: a. TV-Base b. SCART adaptor</p>	 <p>a. b.</p>

DESCRIPTION OF DEVICE

The TV-DEX comprises a TV-Controller (1) and a TV-Base (2).

1. TV-Controller II

2. TV-Base

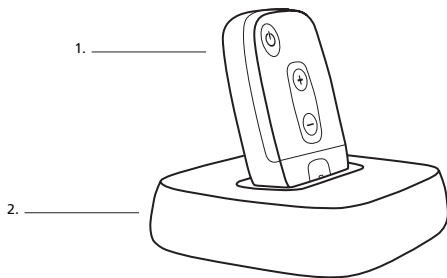

If you need help to identify the serial number (usually six or seven digits) on the product, please contact your hearing care professional.

**WARNING**

This booklet contains important information and instructions. Please read this booklet carefully before you start using the device.

Intended use

The TV-DEX is a wireless device intended for listening directly to the TV or other audio sources.

TV-CONTROLLER II

The controller is provided with four keys:

1. **Transmission on/off**
2. **Room off**
3. **Volume up**
4. **Volume down**

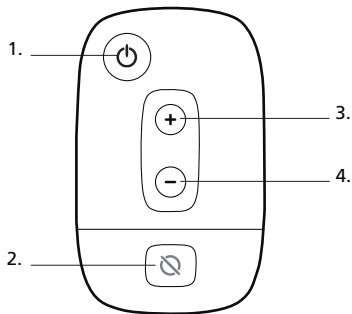

TV-BASE

On the back of the base you will find the following inputs:

1. Power
2. TV
3. Audio

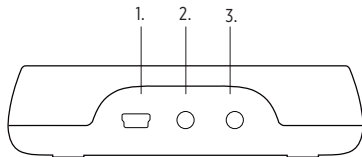

On the underside of the base there is a switch with a choice of two settings:

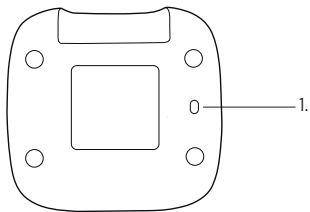

1. Monaural/binaural switch

The setting chosen by your hearing care professional depends on whether you use a hearing aid in only one ear (monaural) or in both ears (binaural).

LIGHT-EMITTING DIODES

There are two light-emitting diodes (LEDs) on the controller.

1. **Constant green light:** Transmission
2. **Changing from green to red:** Transmission off
3. **Constant red light:** Room off active
4. **Flashing red and green light:** Battery charging

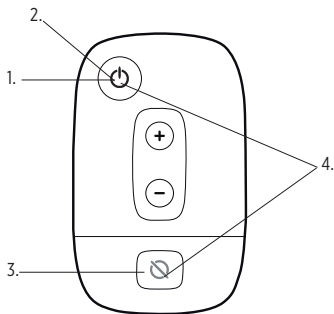

GETTING STARTED

You can skip steps 5+6 if you only wish to transmit from the TV, and steps 3+4 if you only wish to transmit from an audio source.

Connecting the units:

1. Connect the mini-USB power supply unit to the base.
(The supply unit is supplied with 4 plugs. Connect the plug used in your country as illustrated).
2. Plug the other end into a wall socket.

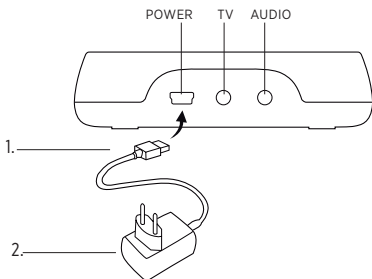

TV:

- 3a. Connect the jack to phono cable to the base.
- 4a. Plug the two phono connectors at the other end of the cable into AUDIO OUT on the TV. Please refer to the user guide for your TV for further details.

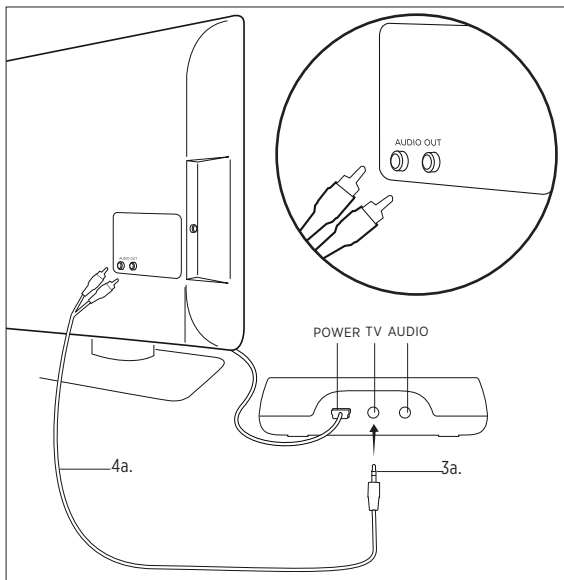

If the TV has no AUDIO OUT, a SCART adaptor should be used:

- 3b. Connect the phono connectors to the two terminals on the included SCART adaptor (red to red and white to white).
- 4b. Plug the SCART adaptor into the TV's SCART socket.

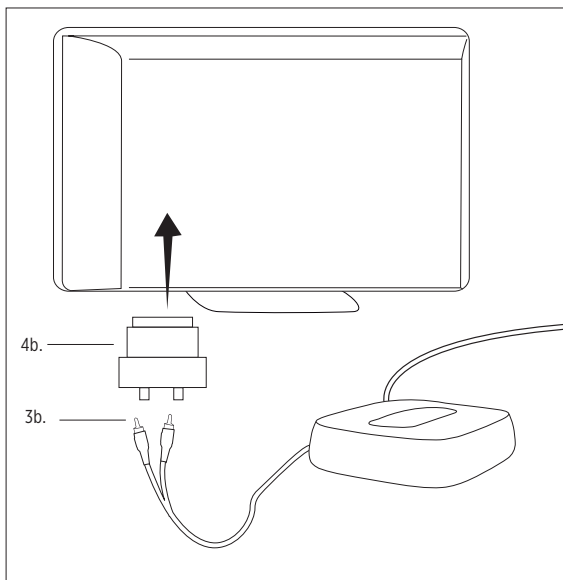

Audio:

5. Plug the jack to jack cable into the audio input on the base.
6. Connect the other end to the audio source (e.g. a stereo system).

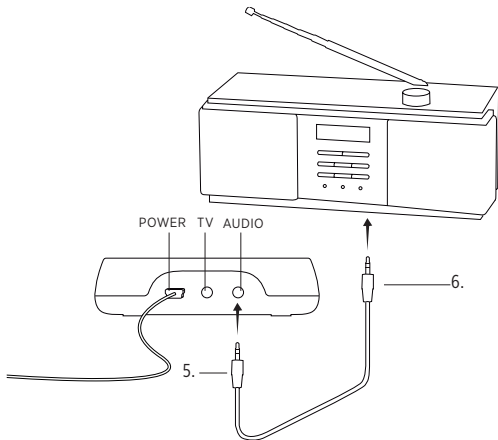

7. Place the controller in the base and allow it to charge for eight hours (the first time).

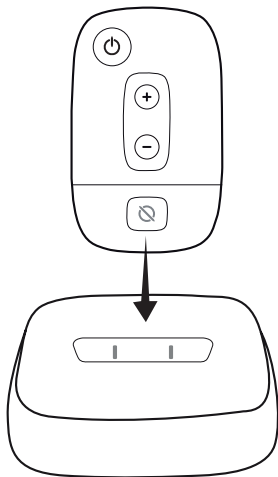

When using more than one tv-base

If you only have one base, this base is automatically selected the first time you charge the controller in the base. If you have more than one base, you can change between these by placing the controller in the base you wish to use for approx. 5 seconds.

USAGE

We recommend that you hang the controller around your neck when in use, on the lanyard provided.

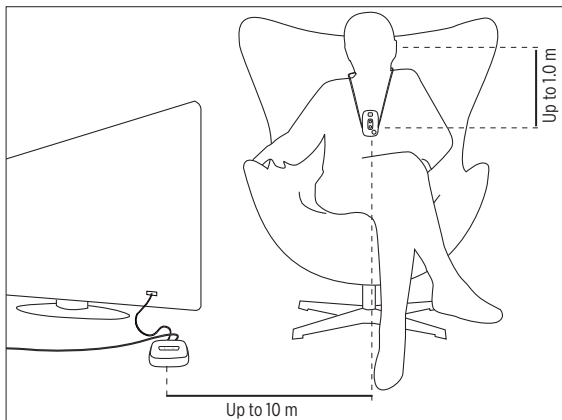

INSTRUCTIONS FOR LANYARD USAGE

Place the controller in the plastic holder at the end of the lanyard as illustrated.

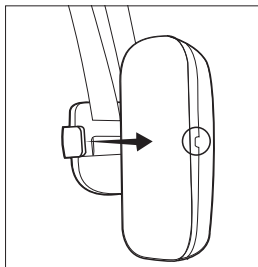
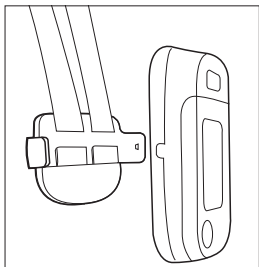

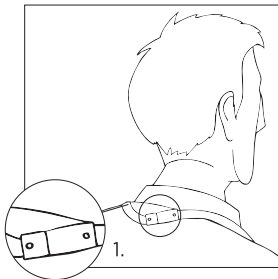
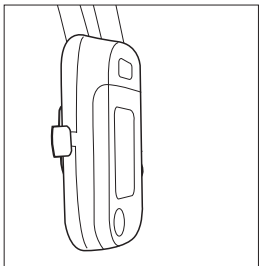

WARNING

The breakaway buckle of the lanyard must be positioned at the back of your neck (1).



TRANSMISSION

With either TV or audio connected

- Press the transmission on/off key on the controller once to start transmitting from the connected source. An acoustic signal will sound in your hearing aids, and the transmission LED will turn green.
- Press the key again once to stop transmission. The hearing aids will enter the Master program as indicated by a voice message or beep tones. The green LED will change briefly to red and then off.

With both TV and audio connected:

- Press the transmission on/off key on the controller once to start transmission from the TV. An acoustic signal will sound in your hearing aids, and the transmission LED will turn green.
- Press the key a second time to transmit sound from the audio source instead. An acoustic signal will sound in your hearing aids.

- Press the key a third time to stop transmission. The hearing aids will enter the Master program, as indicated by a voice message or beep tones. The green LED will change briefly to red and then off.

If you carry your controller around with you and move outside the operating range, transmission will be interrupted and your hearing aids will switch to the Master program. The LED will flash at slow intervals to indicate that transmission has been interrupted. The change will be indicated by a voice message. If your hearing aids are set up with beep-tone indication instead, no acoustic indication will sound.

If you come in range again, the controller will detect the signal from the TV/Audio and restart transmission. A sound will be heard in the hearing aids. The LED will light constantly rather than flash.

Note that the LED may continue to be red if you chose to turn off the hearing aid microphones during transmission.

Adjusting the volume

Press the volume up key to raise the volume of the transmitted TV or audio sound. Press the volume down key to lower the volume.

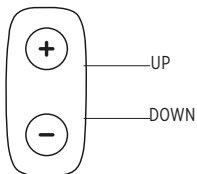

Mute

You can mute the transmitted TV or audio sound on the TV or audio source.

Room off



If you wish to turn the hearing aid microphones off during transmission, so that you only hear the transmitted sound, press the room on/off key once. To turn the microphones back on, press again. An acoustic indicator will sound in your hearing aids, and the red LED will turn off.

Recharging the battery

The controller uses a rechargeable battery. When fully charged, the battery has a capacity of approx. 10 hours of transmission, decreasing over time. When the battery runs low, transmission is interrupted. To recharge the battery, place the controller in the base for approximately 4 hours.

You can also recharge the battery using an appropriate USB power supply supplied by Widex.

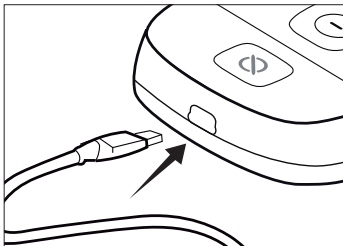



WARNING

Do not attempt to change the battery. Contact your hearing care professional.

CARING FOR YOUR TV-DEX

The device is a valuable object and should be treated with care. Here are some things you can do to prolong the life of your device:



WARNING

- Do not expose the device to extreme temperatures or high humidity.
- Do not immerse it in water or other liquids.



CAUTION

- Clean the device with a soft cloth. Never clean it with acids, alcohol, strong detergents or other liquids.
- Avoid dropping the device
- It is not recommended to keep your mobile phone/PDA within close proximity of the device e.g. same pocket.
- Never try to open or repair the device yourself. (To be performed by authorized personnel only).



WARNING

- **Do not carry your device with you during X-rays, MRIs and other scans or radiation treatments** and never place your device in a microwave oven. These are some of the types of radiation that can damage your device.
- Radiation from room surveillance equipment, burglar alarms, mobile phones and similar sources is weaker and will not damage your device. However, on occasion radiation from devices such as certain burglar alarms, automatic motion detectors and other electronics may cause noticeable audible interference during device and hearing aid use.

WARNINGS



WARNING

- Keep the TV-DEX and its parts and accessories out of reach of children and anyone else who might swallow parts of the device, or otherwise cause injury to themselves with these items. In case of ingestion, contact a physician immediately.
- Do not use the device on aircraft or in hospitals without permission.
- Do not use the device in mines or other areas with explosive gases.



CAUTION

- Although your device has been designed to comply with the most stringent international electromagnetic compatibility standards, the possibility cannot be excluded that it may cause interference with other equipment, such as medical devices.



WARNING

Interference with active Implants

- In order to show caution, we advise to follow the guidelines recommended by manufacturers of defibrillators and pacemakers regarding use of mobile phones:
- If you wear an active implantable device keep the Wireless Hearing Aids and Hearing Aid Accessories such as wireless devices or communicators at least 15 cm away from the implant.
- If you experience any interference, do not use the hearing aids and/or hearing aid accessories and contact the manufacturer of the implant. Please note that interference can also be caused by power lines, electrostatic discharge, airport metal detectors etc.
- If you have an active brain implant, please contact the manufacturer of the implant for risk evaluation.

If you have an implantable device, we advise to keep magnets* at least 15 cm away from the implant. (*= can be specified as Autophone magnet, hearing instrument case, magnet in a tool, etc.)

SAFETY WARNING

This device is powered by an external power supply.

- Only connect a power supply that is compatible with the TV-DEX.
- The power supply must have an output rating of 5VDC, 500mA and mini USB connector.
- The power supply input rating voltage must match the mains power voltage in your region and the power supply must have a mains male plug that is compatible with the AC wall socket in your region
- The power supply must be designed for ITE and must have the certification marks showing certification by an agency acceptable in your region.

Widex strongly recommends that you always use a power supply that is delivered by your Widex Distributor to ensure safe and efficient use of your TV-DEX.

TROUBLESHOOTING

Problem	Potential cause	Solution
Your TV-Controller does not work	The battery is exhausted	Charge the battery
	Base has not been selected	Place the TV-Controller in the TV-Base for at least 5 seconds
The green diode on the TV-Controller turns on for a brief period of time and then turns off	The jack plug for tv or audio connection is not connected to the TV-Base	Connect the jack plug as shown on page page 14-16
	The TV-Base is not connected to the electrical mains	Connect the TV-Base as described on page page 13

Problem	Potential cause	Solution
No transmitted sound even if the green diode is turned on	TV/audio source is not switched on	Switch TV/audio source on
	Sound source and TV-Base are not properly connected	Connect the sound source and TV-Base as shown on pages 14, 16, 16
Transmission interrupted	TV-Controller battery is exhausted	Charge the TV-Controller
	TV-Controller is out of operating range	Move within operating range
When transmitting, parts of the sound image from the TV/audio source are missing	Monaural/binaural switch on the underside of the TV-Base is not set correctly	Check that the switch is in the correct position. See page 9.

Problem	Potential cause	Solution
Volume of transmitted sound changes when you adjust the volume of the sound source	TV-Base is not connected to the correct output	Connect the TV-Base to the correct TV/audio output. Please refer to the user instructions for the TV/audio source.

REGULATORY INFORMATION

FCC ID: TTY-TVB

FCC ID: TTY-TVC2

IC: 5676B-TVB

IC: 5676B-TVC2

Federal Communications Commission Statement

This device complies with part 15 of the FCC Rules. Operation is subject to the following two conditions:

- (1) This device may not cause harmful interference, and
- (2) this device must accept any interference received, including interference that may cause undesired operation.

NOTE:

This equipment has been tested and found to comply with the limits for a Class B digital device, pursuant to part 15 of the FCC Rules. These limits are designed to provide reasonable protection against harmful interference in a residential installation. This equipment generates, uses and can radiate radio frequency energy and, if not installed and used in accordance with the instructions, may cause harmful interference to radio communications. However, there is no guarantee that interference

will not occur in a particular installation. If this equipment does cause harmful interference to radio or television reception, which can be determined by turning the equipment off and on, the user is encouraged to try to correct the interference by one or more of the following measures:

- Reorient or relocate the receiving antenna.
- Increase the separation between the equipment and receiver.
- Connect the equipment into an outlet on a circuit different from that to which the receiver is connected.
- Consult the dealer or an experienced radio/TV technician for help.

NOTE:

This equipment complies with FCC radiation exposure limits set forth for an uncontrolled environment. This transmitter must not be co-located or operating in conjunction with any other antenna or transmitter.

Changes or modifications to the equipment not expressly approved by WSAUD A/S could void the user's authority to operate the equipment.

Industry Canada Statement / Déclaration d'industrie Canada

Under Industry Canada regulations, this radio transmitter may only operate using an antenna of a type and maximum (or lesser) gain approved for the transmitter by Industry Canada.

To reduce potential radio interference to other users, the antenna type and its gain should be so chosen that the equivalent isotropically radiated power (e.i.r.p.) is not more than that necessary for successful communication.

This device complies with Industry Canada licence-exempt RSS standard(s). Operation is subject to the following two conditions:

- (1) this device may not cause interference, and
- (2) this device must accept any interference, including interference that may cause undesired operation of the device.

Conformément à la réglementation d'Industrie Canada, le présent émetteur radio peut fonctionner avec une antenne d'un type et d'un gain maximal (ou inférieur) approuvé pour l'émetteur par Industrie Canada.

Dans le but de réduire les risques de brouillage radioélectrique à l'intention des autres utilisateurs, il faut choisir le type d'antenne et son gain de sorte que la puissance isotrope rayonnée équivalente (p.i.r.e.) ne dépasse pas l'intensité nécessaire à l'établissement d'une communication satisfaisante.

Le présent appareil est conforme aux CNR d'Industrie Canada applicables aux appareils radio exempts de licence. L'exploitation est autorisée aux deux conditions suivantes :

- (1) l'appareil ne doit pas produire de brouillage, et
- (2) l'utilisateur de l'appareil doit accepter tout brouillage radioélectrique subi, même si le brouillage est susceptible d'en compromettre le fonctionnement.

Directive 1999/5/EC

Hereby, WSAUD A/S declares that the TV-Controller and TV-Base are in compliance with the essential requirements and other relevant provisions of Directive 1999/5/EC.

A copy of the Declaration of Conformity according to 1999/5/EC can be found at:

<http://www.widex.com/doc>









Electrical and electronic equipment (EEE) contains materials, components and substances that can be hazardous and present a risk to human health and the environment when waste electrical and electronic equipment (WEEE) is not handled correctly.





Do not dispose of hearing aids, hearing aid accessories and batteries with ordinary household waste.





Hearing aids, batteries and hearing aid accessories should be disposed of at sites intended for waste electrical and electronic equipment, or given to your hearing care professional for safe disposal. Proper disposal helps to protect human health and the environment.





SYMBOLS

Symbols commonly used by WSAUD A/S in medical device labelling (labels/IFU/etc.)

Symbol	Title/Description
	Manufacturer The product is produced by the manufacturer whose name and address are stated next to the symbol. If appropriate, the date of manufacture may also be stated.
	Date of manufacture The date when the product was manufactured.
	Use-by date The date after which the product is not to be used.
	Batch code The product's batch code (lot or batch identification).

Symbol	Title/Description
	Catalogue number The product's catalogue (item) number.
	Serial number The product's serial number.*
	Keep away from sunlight The product must be protected from light sources and/or The product must be kept away from heat
	Keep dry The product must be protected from moisture and/or The product must be kept away from rain
	Lower limit of temperature The lowest temperature to which the product can be safely exposed.

Symbol	Title/Description
	<p>Upper limit of temperature</p> <p>The highest temperature to which the product can be safely exposed.</p>
	<p>Temperature limits</p> <p>The highest and lowest temperatures to which the product can be safely exposed.</p>
	<p>Consult instructions for use</p> <p>The user instructions contain important cautionary information (warnings/precautions) and must be read before using the product.</p>
	<p>Caution/Warning</p> <p>Text marked with a caution/warning symbol must be read before using the product.</p>

Symbol	Title/Description
	<p>WEEE mark “Not for general waste”</p> <p>When the product is to be discarded, it must be sent to a designated collection point for recycling and recovery.</p>
	<p>CE mark</p> <p>The product is in conformity with the requirements set out in European CE marking directives.</p>
	<p>Alert</p> <p>The product is identified by R&TTE Directive 1999/5/EC as an equipment Class 2 product with some restrictions on use in some CE member states.</p>
	<p>RCM mark</p> <p>The product complies with electrical safety, EMC and radio spectrum regulatory requirements for products supplied to the Australian or New Zealand market.</p>

Symbol	Title/Description
	Interference Electromagnetic interference may occur in the vicinity of the product.

*The six- or seven-digit number on the product is the serial number. Serial numbers may not always be preceded by **SN**



WSAUD A/S

Nymoellevej 6, DK-3540 Lyngbe, Denmark
<https://global.widex.com>



Manual no.:
9 514 0130 001 #09
Issue:
2020-11

